

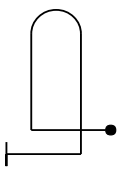
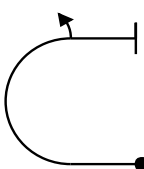
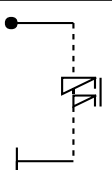
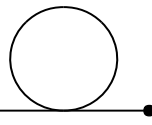

Pilot ID

SAC Sportsman Known

Flight #

No	Symbol	Cat. No.	K	Total K	Marks	Remarks	Pos	Item	K	Grade
1		<b>8.4.1.1</b>	<b>13</b>	13				Pos.	20	
2		<b>7.2.2.1</b> <b>9.1.3.2</b>	<b>6</b> <b>4</b>	10				Fig K		Total K
								118		138
								<b>Penalties</b>		
3		<b>1.1.6.3</b> <b>9.11.1.6</b>	<b>10</b> <b>3</b>	13				Too Low		
								Too High		
								Interruptions		
								Insertions		
4		<b>7.4.1.1</b>	<b>10</b>	10				Trg Violation		
								Wing Rocks		
								Disqual Fig		
								Other(note...)		
5		<b>5.2.1.1</b>	<b>17</b>	17				<b>Final Freestyle</b>		
								Duration	Min	Sec
6		<b>1.2.3.1</b> <b>9.4.2.2</b>	<b>12</b> <b>7</b>	19				<b>Judges Details</b>		
								Signature		
								Name		
								Number		
7		<b>1.1.1.1</b> <b>9.2.3.4</b>	<b>2</b> <b>9</b>	11						
8		<b>8.5.6.1</b> <b>9.1.4.2</b>	<b>10</b> <b>4</b>	14						
9		<b>8.6.1.1</b>	<b>11</b>	11						

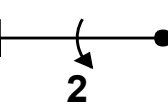
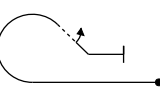
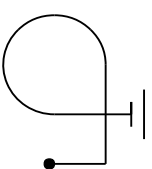
\_\_\_\_\_  
Pilot

\_\_\_\_\_  
A/C

2017		Form B
Pilot ID	SAC Sportsman Known	
	Flight #	

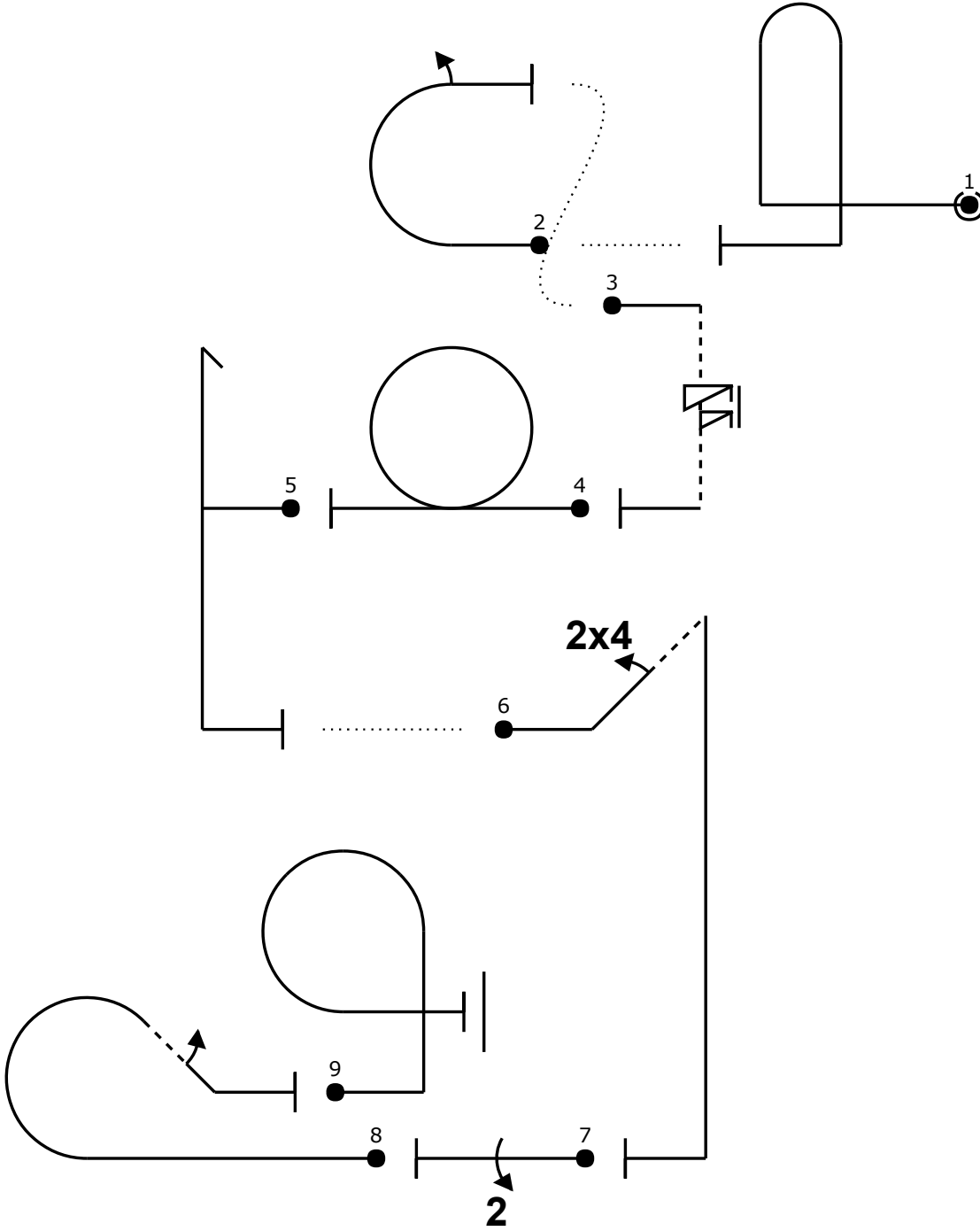
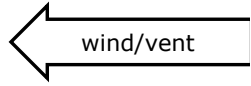

Power			
Fig 1	8.4.1.1	13	13
Fig 2	7.2.2.1 9.1.3.2	6 4	10
Fig 3	1.1.6.3 9.11.1.6	10 3	13
Fig 4	7.4.1.1	10	10
Fig 5	5.2.1.1	17	17
Fig 6	1.2.3.1 9.4.2.2	12 7	19
Fig 7	1.1.1.1 9.2.3.4	2 9	11
Fig 8	8.5.6.1 9.1.4.2	10 4	14
Fig 9	8.6.1.1	11	11
<b>Total K = 118</b>			

\_\_\_\_\_  
 ..... Pilot  
 ..... A/C

2017		Form C
Pilot ID	SAC Sportsman Known	Flight #

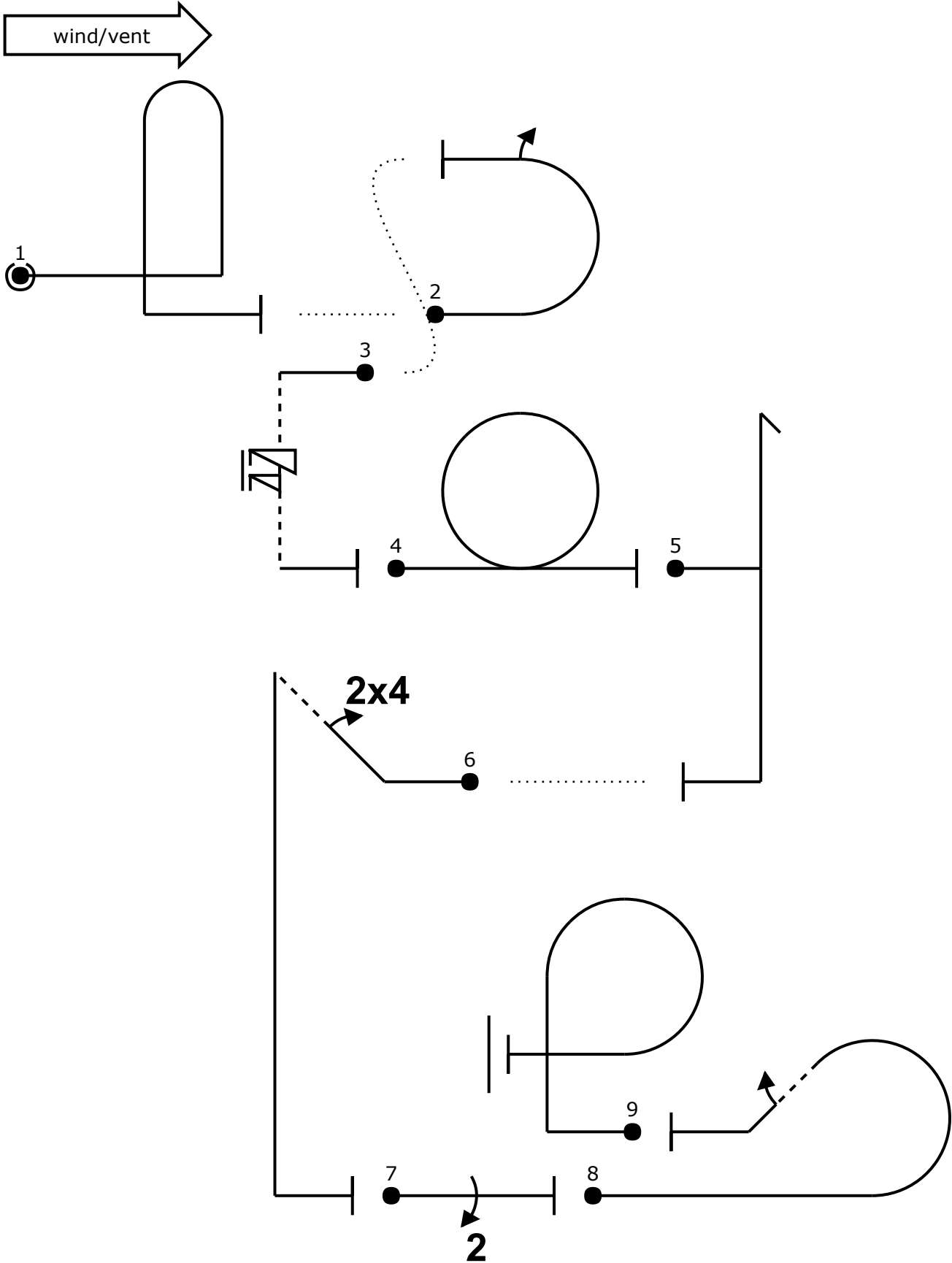

Pilot  
A/C